

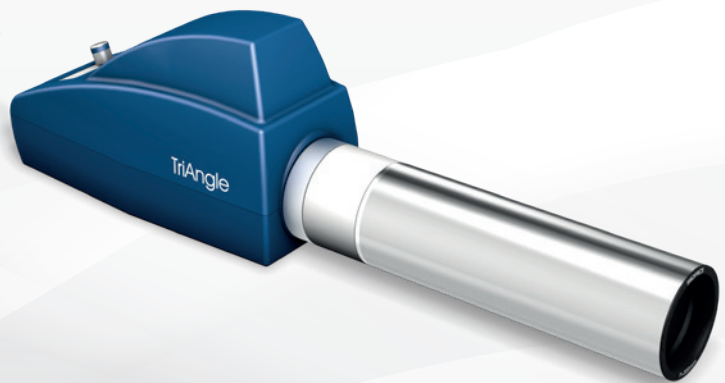

## TriAngle



Electronic autocollimator for  
precise angle measurement





# Passion for optics

---

TRIOPTICS develops and produces the world's largest range of optical measurement and manufacturing technology for the development, quality control and production of lenses, lens systems and camera modules.



# TriAngle

---

## Key features TriAngle electronic autocollimators

- Electronic Autocollimators for Optical Angle Measurement
- Measurement of angular displacements with highest accuracy
- Wide range of application specific variants with a modular design
- Effective focal lengths from 100 – 1,000 mm
- Different sensors, reticles and light sources available
- Accuracy performance up to 0.05 arcseconds
- OptiAngle® Software package for angle measurements

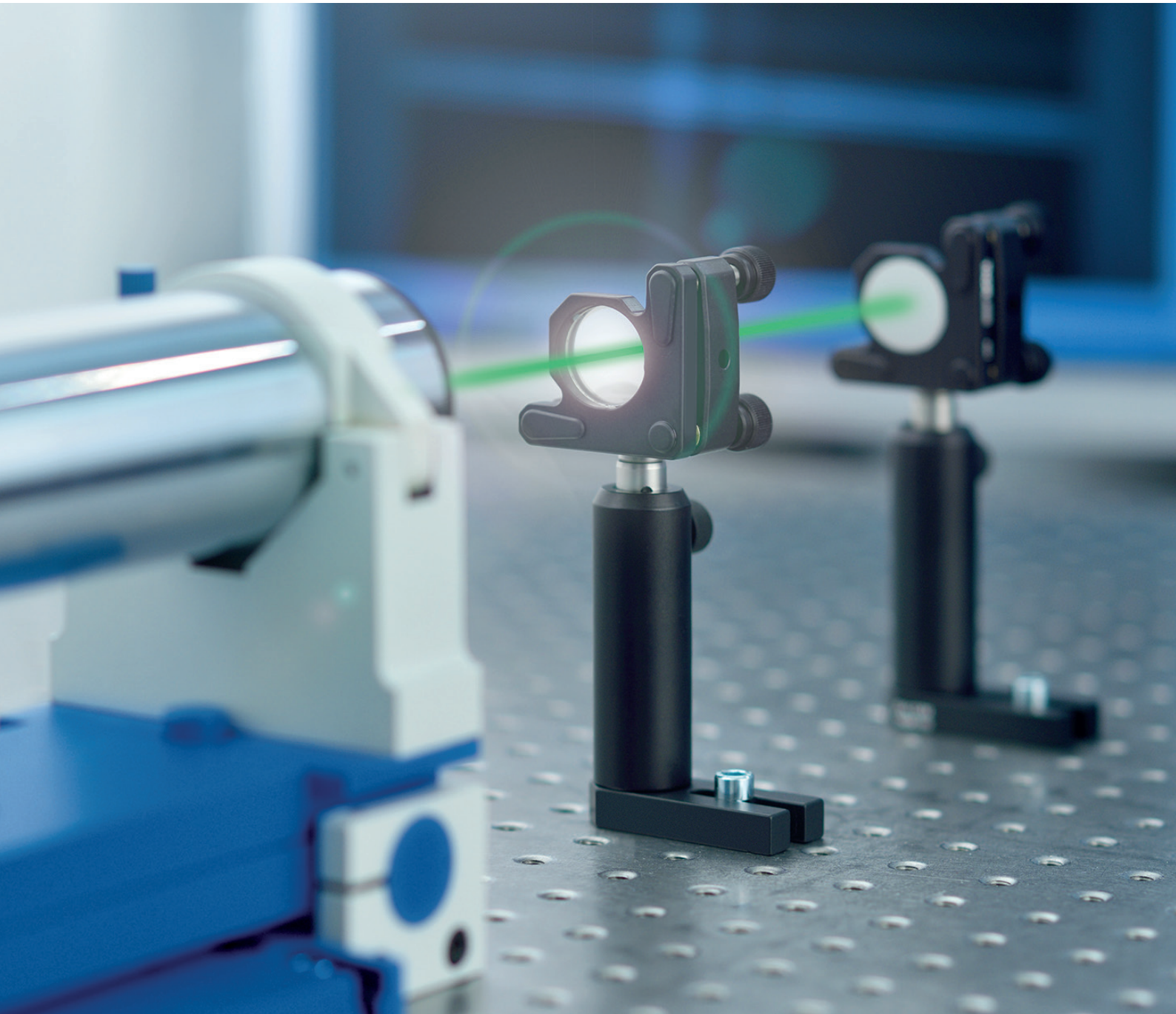

# TriAngle

## Principle of an electronic autocollimator

The autocollimator combines both optical tools, the collimator and the telescope into one instrument using a single objective lens. Both beam paths are separated by using a beam splitter. The autocollimator is a very sensitive angle measuring device and is thus used for the precise angular adjustment of optical or machine components. Due to the collimated beam (infinity adjustment) the measurement results are independent from the distance to the object under test.

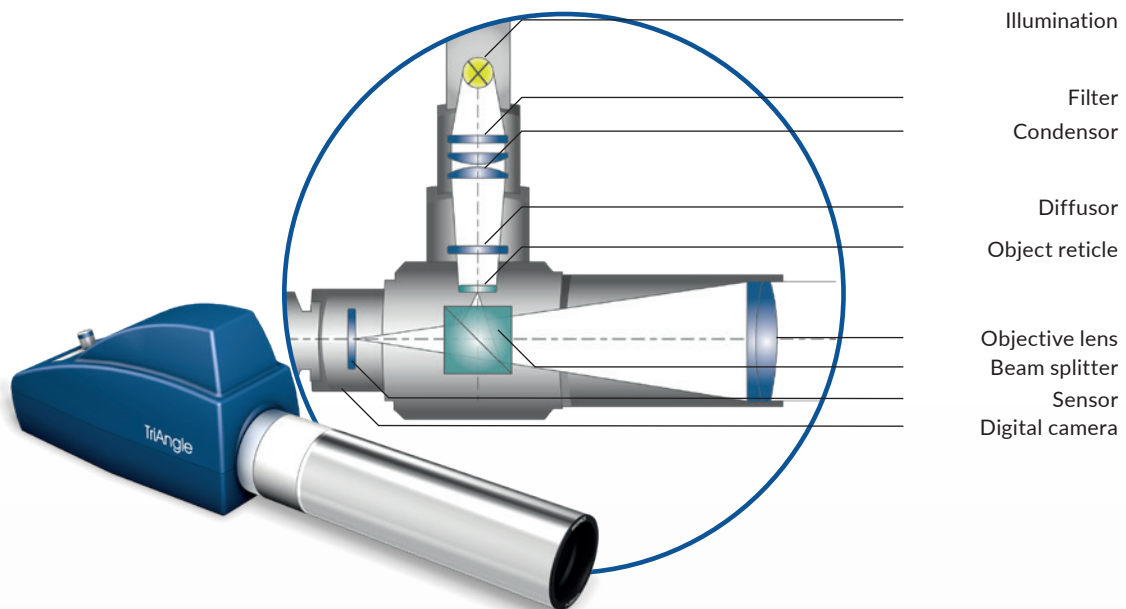

In an electronic autocollimator the eyepiece is replaced by an electronic camera with discrete sensor pixels (e.g. CCD or CMOS sensor type). It can be of a 2D frame type allowing angular measurements in two directions, or a 1D line scan sensor for single axis measurements. The digital camera is usually connected to a PC which calculates the measured angle from the image by using image analysis software. The high resolution of electronic autocollimators is due to the evaluation of gray scale levels in the image which allows for sub pixel interpolation of the image position. Depending on the focal length of the objective lens and the stability of the setup, angular resolutions of 1/100 up to 1/1,000 arcsecs can be achieved.

# TriAngle

## Electronic autocollimator

The TriAngle electronic autocollimators are non-contact optical test tools for the high-precision measurement of angular displacements of specular reflective surfaces and the accurate angular alignment of optical or mechanical parts. TriAngle autocollimators have a versatile modular design which allows them to be fitted with a wide selection of objective tubes, different sensors,

reticles and light sources. With objective tubes of different focal lengths and apertures, the optimum measurement solution regarding angle resolution and measurement range is easily found.

TriAngle autocollimators are available in different application-specific variants:



TriAngle

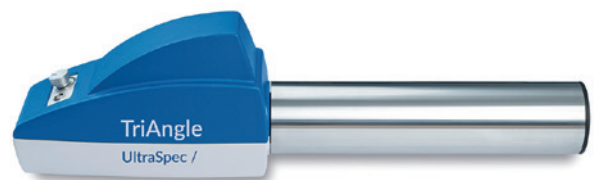

TriAngle UltraSpec



TriAngle Laser



TriAngle NIR



TriAngle LargeField



TriAngle Focus

Special solutions adapted to your requirements on request.  
Please contact us if you have special requirements!

# TriAngle

## Productgroup overview

### TriAngle

The standard instrument offering a maximum set of measurement functions.

- LED light source of 525 nm
- High resolution camera
- Focal lengths ranging from 100 mm to 1,000 mm
- Accuracy performance of up to 0.2 arcsec



### TriAngle UltraSpec

For highest demands on angle resolution and measurement accuracy.

- LED light source of 525 nm
- High resolution camera with extremely low sensor noise
- Objective lens of minimum distortion
- Thermally and mechanically optimized design
- Focal lengths 300 mm or 500 mm
- Accuracy performance of up to 0.05 arcsec
- Calibrated with PTB angle standards

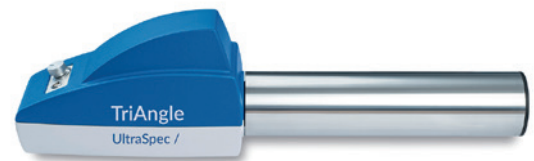

### TriAngle Laser

Ideal for the measurement of small optical components, surfaces of low reflectivity or long distance measurements.

- Laser illumination with wavelengths of 635 nm
- Focal lengths ranging from 100 mm to 1,000 mm
- Accuracy performance of up to 0.25 arcsec



### TriAngle NIR

For applications that require measurement at the design wavelengths in the NIR.

- Light source with 1,064 nm (other wavelengths available on request)
- Focal lengths ranging from 100 mm to 1,000 mm
- Accuracy performance of up to 0.2 arcsec



### TriAngle LargeField

For applications requiring a large measuring range without compromising the measurement accuracy and resolution.

- LED light source of 525 nm
- Specially calibrated large field sensor and optimized imaging optics
- Available with a focal range of 100 mm
- Accuracy +/- 3 arcsec within 80 % measuring range
- Field of view: 3° x 3°



### TriAngle Focus

For the measurement of slightly spherical surfaces.

- LED light source of 525 nm
- Focusing objective tubes
- Focal lengths ranging from 100 mm to 1,000 mm
- Accuracy performance of up to 0.2 arcsec





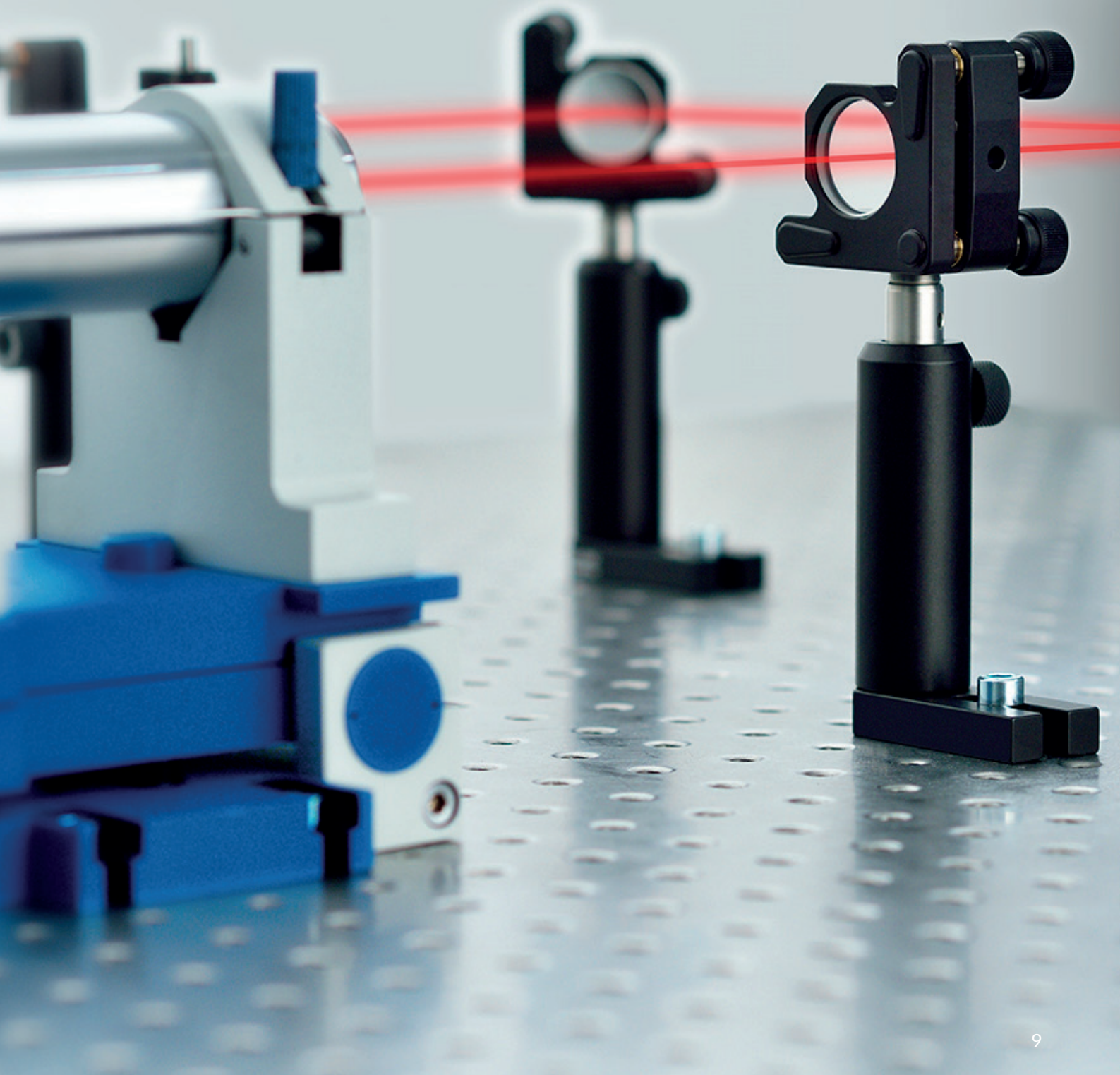

# TriAngle

## Typical TriAngle application

Tilt angle measurement

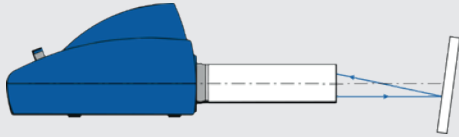

Alignment of optical components

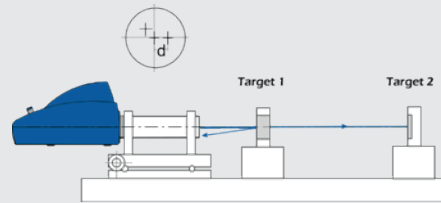

Prism & polygon measurement

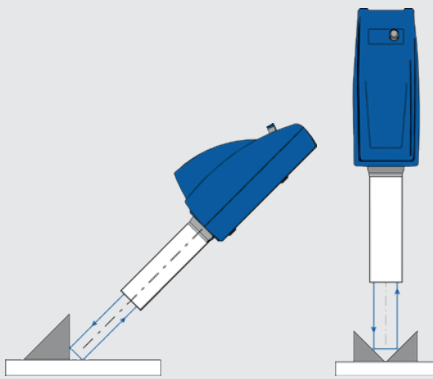

Wedge angle measurement in reflection / double pass

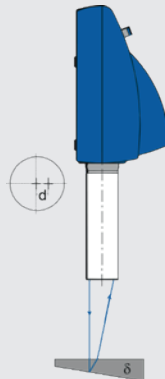

Measurement of slightly curved surfaces

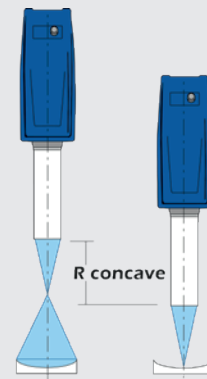

Wobble & vibration measurement

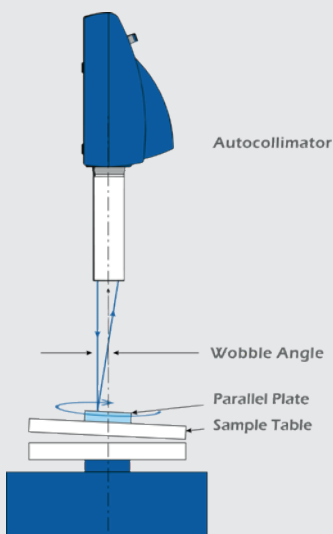

Measurement of flatness / straightness / parallelism

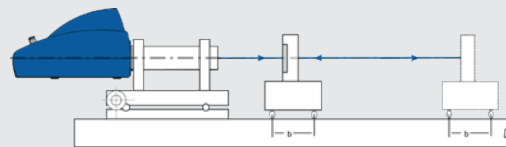

Rotary table calibration

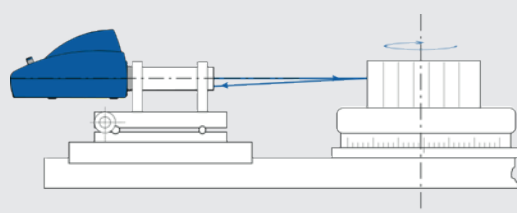

# TriAngle

## Software

### OptiAngle®: The complete software package for angle measurement

The OptiAngle® software is a powerful tool covering all aspects of accurate angle measurement with the TriAngle electronic autocollimators in terms of measurement, control and analysis of the angular data.

The well organized and modern menu guided user interface assists even the inexperienced operator to perform accurate measurements and to obtain repeatable results. A large set of predefined standard measurement applica-

tions is integrated into OptiAngle which cover all established measurement techniques in optical and mechanical industry. In addition, customized measurement routines can be easily developed and embedded either by TRIOPTICS or the experienced end user. All OptiAngle® measurement functions can be further used in other common applications like Lab-View or Visual Basic (Excel).

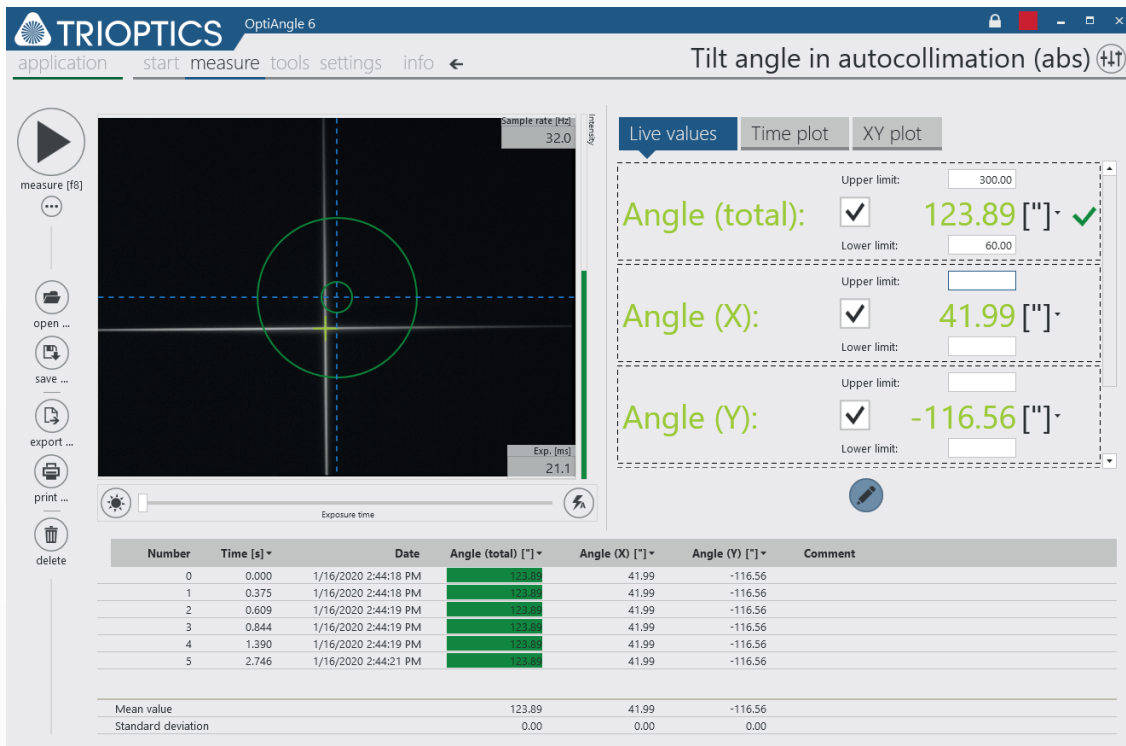

The screenshot displays the OptiAngle 6 software interface. The main window shows a live measurement of a tilt angle in autocollimation (abs). The interface includes a central display area with a green circle and a blue crosshair, and a right-hand panel with live values for Angle (total), Angle (X), and Angle (Y). A table at the bottom shows a list of measurements with columns for Number, Time [s], Date, Angle (total) [°], Angle (X) [°], Angle (Y) [°], and Comment.

Number	Time [s]	Date	Angle (total) [°]	Angle (X) [°]	Angle (Y) [°]	Comment
0	0.000	1/16/2020 2:44:18 PM	123.89	41.99	-116.56	
1	0.375	1/16/2020 2:44:18 PM	123.89	41.99	-116.56	
2	0.609	1/16/2020 2:44:19 PM	123.89	41.99	-116.56	
3	0.844	1/16/2020 2:44:19 PM	123.89	41.99	-116.56	
4	1.390	1/16/2020 2:44:19 PM	123.89	41.99	-116.56	
5	2.746	1/16/2020 2:44:21 PM	123.89	41.99	-116.56	
Mean value			123.89	41.99	-116.56	
Standard deviation			0.00	0.00	0.00	

OptiAngle®-software for electronic autocollimators

# TriAngle

## Software features and functions

The TriAngle software provides many features to simplify the daily use of TriAngle autocollimators whether in the laboratory or in the production environment.

- Real-time camera display
- Numerical and graphical display of measurement data
- Optional full screen camera window (visual alignment mode)
- User defined graphical scales or indicators inside the camera window
- Simultaneous measurement with multiple (up to 12) autocollimators
- Simultaneous measurement of multiple surface reflections (up to 12)
- Comprehensive data reporting functions
- ASCII (CSV) data export
- Selectable angle units for screen display and measurement certificate
- Software remote control by host computer via RS232 interface and TCP / IP
- Plug-in mechanism for customized measurement programs
- User defined measurement certificate layout
- Demo programming examples for Excel, LabView, VBA
- Multiple camera interface technology for USB, IEEE 1394 (firewire), gigabit ethernet, camera-link or analog video camera
- Production mode for batch/lot sample identification and result reporting

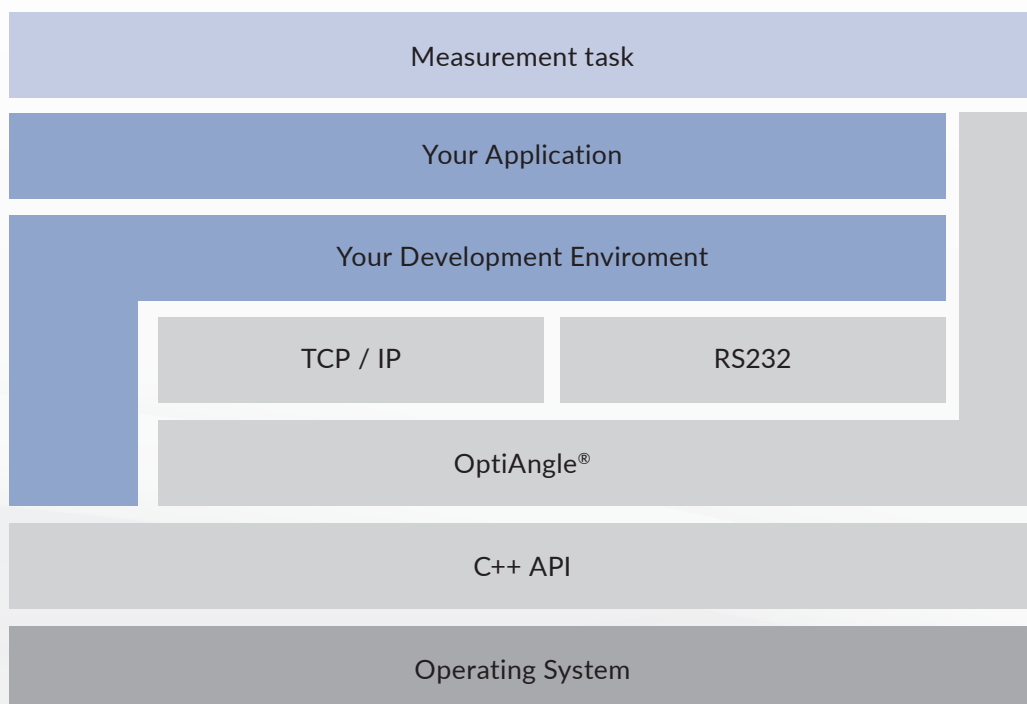

Modular software concept

# TriAngle

## Accessories

In addition to the TriAngle electronic autocollimator series, TRIOPTICS offers a large range of opto-mechanical accessories, often required for certain standard applications.

### Holders

Clamp Fixture

Adjustable Holders

Stands

- Manual stand
- Vertical mount D38, D57
- Tripod

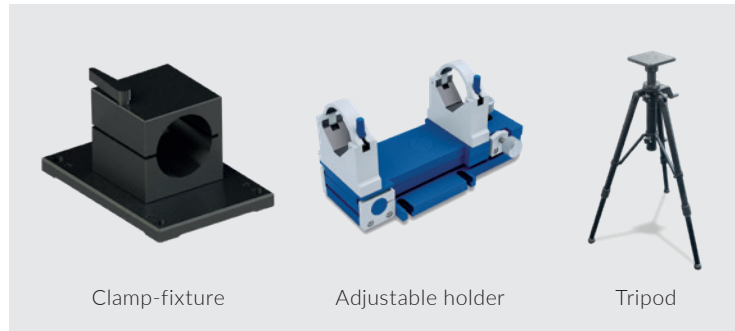

### Alignment tools

Laser prealignment tool

View finder prism

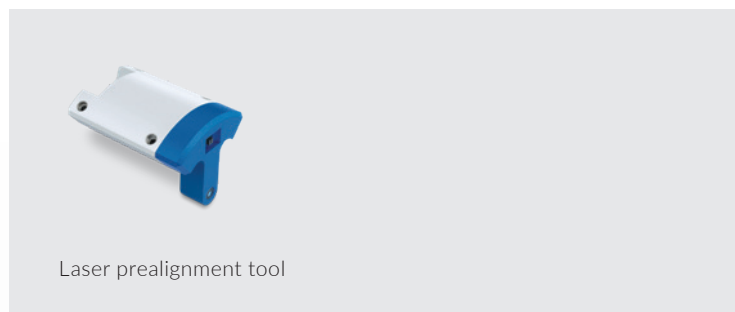

### Mirrors

Mirrors

- Mirror in mount
- Adjustable mirrors

Redirecting mirrors

- 45° redirecting mirror for D38, D57, D115
- Penta prism



### Calibration tools

90° Reference prism in mount

Polygons

- Polygon with 8/12/ 24/36 sides in holder

Calibration wedges

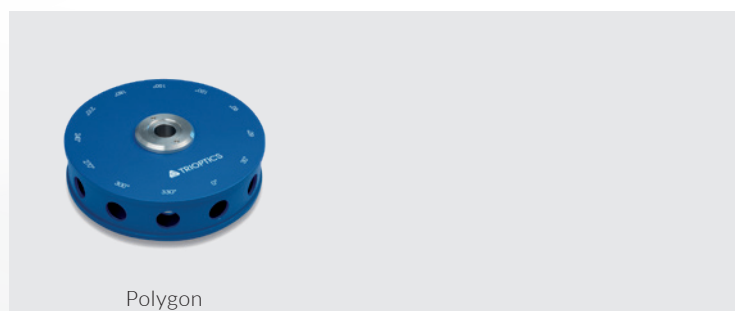

# TriAngle

## Product overview

TriAngle TA	Effective focal length (mm)	Clear aperture (mm)	Accuracy (arc sec)	Field of view (arc sec)	Measurement frequency (Hz)
				USB 3.0	USB 3.0
TA 100-38	100	26	2.5	6,170 x 4,940	Up to $\geq$ 100Hz depending on settings (shutter time) and measurement conditions
TA 150-38	150	30	1.7	4,120 x 3,300	
TA 200-38	200	30	1.3	3,090 x 2,470	
TA 300-38	300	30	0.75	2,060 x 1,650	
TA 300-57	300	48	0.75	2,060 x 1,650	
TA 500-57	500	48	0.4	1,240 x 980	
TA 1000-115	1,000	100	0.2	610 x 490	
TA 1000-140	1,000	125	0.2	610 x 490	

## TriAngle UltraSpec

TA US 300-57	300	45	$\pm 0.05$ over range of 10 arcsec	3,000 x 1,920	Up to $\geq$ 100Hz depending on settings (shutter time) and measurement conditions
TA US 500-57	500	45	$\pm 0.10$ over range of 20 arcsec $\pm 0.25$ over total FOV	1,800 x 1,150	

## TriAngle Laser

TA L 100-38	100	26	2.5	6,170 x 4,940	Up to $\geq$ 100Hz depending on settings (shutter time) and measurement conditions
TA L 150-38	150	30	1.7	4,120 x 3,300	
TA L 200-38	200	30	1.2	3,090 x 2,470	
TA L 300-38	300	30	0.8	2,060 x 1,650	
TA L 300-57	300	48	0.8	2,060 x 1,650	
TA L 500-57	500	48	0.5	1,240 x 980	
TA L 1000-115	1,000	100	0.25	610 x 490	
TA L 1000-140	1,000	125	0.25	610 x 490	

TriAngle TA, UltraSpec – Illumination: high power LED at 525 nm or 625 nm

TriAngle Laser – Illumination: Laser diode at 635 nm

TriAngle NIR	Effective focal length (mm)	Clear aperture (mm)	Accuracy (arc sec)	Field of view (arc sec)	Measurement frequency (Hz)
				USB 3.0	USB 3.0
TA NIR 100-38	100	26	2.5	6,170 x 4,940	Up to ≥ 100Hz depending on settings (shutter time) and measurement conditions
TA NIR 150-38	150	30	1.7	4,120 x 3,300	
TA NIR 200-38	200	30	1.3	3,090 x 2,470	
TA NIR 300-38	300	30	0.75	2,060 x 1,650	
TA NIR 300-57	300	48	0.75	2,060 x 1,650	
TA NIR 500-57	500	48	0.4	1,240 x 980	
TA NIR 1000-115	1,000	100	0.2	610 x 490	
TA NIR 1000-140	1,000	125	0.2	610 x 490	

### TriAngle LargeField

TA LF 100-38	100	26	3	3° x 3°	4
--------------	-----	----	---	---------	---

### TriAngle Focus

TA F 100-38 ± 10	100	18	2.5	6,170 x 4,940	Up to ≥ 100Hz depending on settings (shutter time) and measurement conditions
TA F 150-38 ± 10	150	26	1.7	4,120 x 3,300	
TA F 200-38 ± 10	200	26	1.3	3,090 x 2,470	
TA F 300-57 ± 25	300	48	0.75	2,060 x 1,650	
TA F 500-57 ± 25	500	48	0.4	1,240 x 980	
TA F 1000-115 ± 50	1,000	100	0.2	610 x 490	
TA F 1000-140 ± 50	1,000	125	0.2	610 x 490	

TriAngle Large Field, Focus – Illumination: high power LED at 525 nm

TriAngle NIR – Illumination: high power LED at 780-1,064 nm



See the Difference

## TRIOPTICS GmbH

Strandbaddamm 6  
22880 Wedel  
Germany

+49 4103 18006-0  
sales@trioptics.com  
www.trioptics.com

